

# ant tracks

## FULL BATTEN MAST TRACKS

Material & finish: hard black anodized and Teflon-coated aluminium. Silver finish only on request.

For sliders with plastic or HS fibre guides

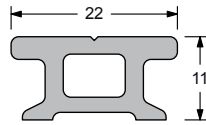

size 22x11 mm  
fasteners: Ø5 mm screws  
mounting slugs available  
length : 2 or 3 m  
page 152

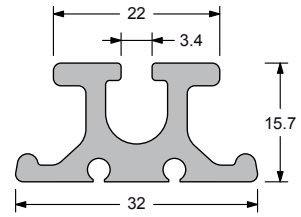

size 22x16 mm  
profile to be glued  
length: 3 m  
page 153

For sliders with HS fibre guides or Fibreball sliders

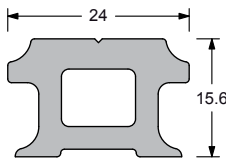

size 24x16 mm  
fasteners: Ø6 mm screws  
mounting slugs available  
length : 2 or 3 m  
page 154

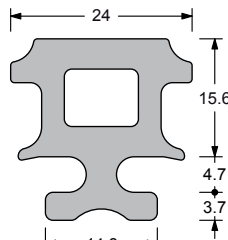

size 24x16 / 4x15 mm  
no fasteners  
mast groove 4x15 mm  
length : 3 m

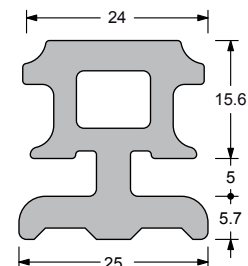

size 24x16 / 6x25 mm  
no fasteners  
mast groove 6x25 mm  
length : 3 m

For Fibreball sliders

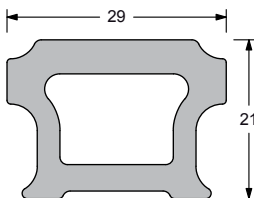

size 29x21 mm  
fasteners: Ø8 mm screws  
mounting slugs available  
length: 3 m  
page 156

For sliders with HS fibre guides

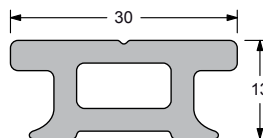

size 30x13 mm  
fasteners: Ø6 mm screws  
no slugs available  
length : 3 or 6 m  
page 155

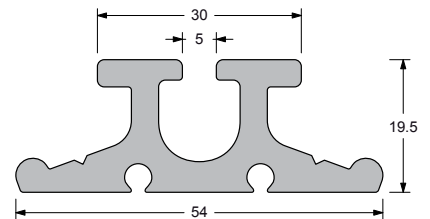

size 30x20 mm  
profile to be glued  
length: 3 m  
page 155



## “T” TRACKS

“T” tracks for sliders with plastic guides.

Material & finish: hard black or silver anodized and Teflon-coated aluminium.

Material & finish: polished 316 stainless steel

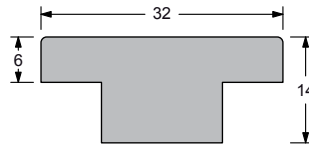

size 32x6 mm  
fasteners: Ø6 mm screws  
any length up to 6 m  
page 108

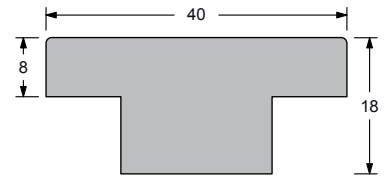

size 40x8 mm  
fasteners: Ø8 mm screws  
any length up to 6 m  
page 108

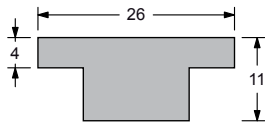

size 26x4 mm  
fasteners: Ø5 mm screws  
any length up to 3 m  
page 96

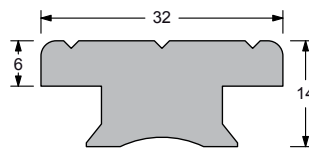

size 32x6 mm  
fasteners: Ø6 mm screws  
any length up to 6 m  
page 98

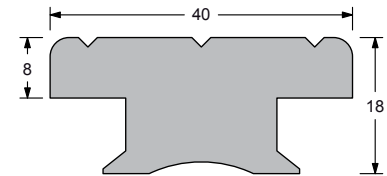

size 40x8 mm  
fasteners: Ø8 mm screws  
any length up to 6 m  
page 100

## 4RACE TRACKS

4Race tracks for ball bearings sliders.

Material & finish: hard black anodized and Teflon-coated aluminium. Silver finish only on request.

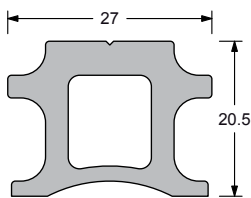

size 27x20 mm  
fasteners: Ø6 mm screws  
any length up to 6 m  
page 113

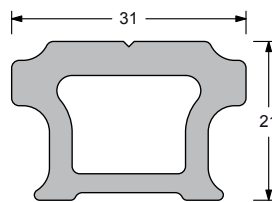

size 31x21 mm  
fasteners: Ø8 mm screws  
any length up to 6 m  
page 116

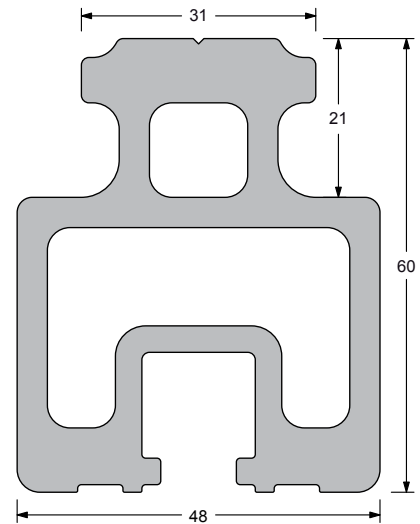

size 31x60 mm  
fasteners: Ø8 mm screws on  
sliding slugs  
any length up to 6 m  
page 116

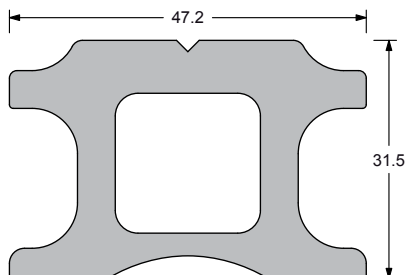

size 47x31.5 mm  
fasteners: Ø10 mm screws  
any length up to 6 m  
page 128

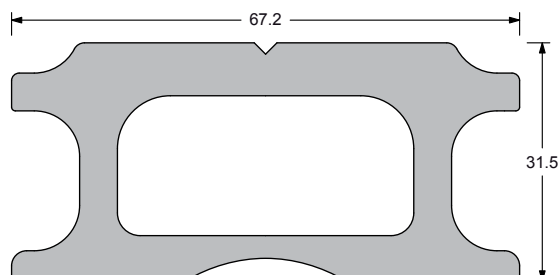

size 67x31.5 mm  
fasteners: Ø12 mm screws  
any length up to 6 m  
page 132